

Standard Specifications

Parameter	Symbol	Specification	Remarks
Frequency Range	f_0	32.768 kHz	20kHz to 100kHz available
Frequency Tolerance	$\Delta f/f$	± 20 PPM	at 25°C with 100 μ W
Frequency Stability	Over OTR	-0.034 \pm 0.006ppm/ $^{\circ}$ C ²	
Operating Temperature Range	T _{OPR}	-40°C to +85°C	
Storage Temperature Range	T _{STG}	-55°C to +125°C	
Load Capacity	C _L	12.5pF (Std value)	Please specify
Drive-Level	D _L	1.0 μ W Typ.	1.0 μ W Max
ESR	R	65 k Ω	Max.
Shunt Capacitance	C ₀	0.8pF	Typical
Ageing	Fa	± 3.0 PPM	Max. at 25°C $\pm 3^{\circ}$ C 1st Year

X-Cut Temperature Characteristics

Reflow Solder Condition (260°C Max.)

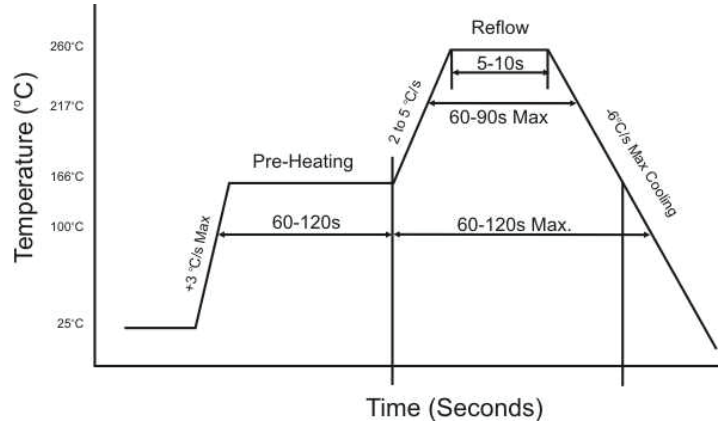
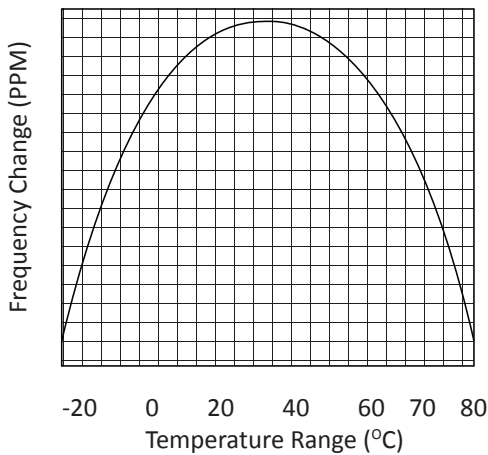

High temperature solder exemption - In accordance with RoHS 2002/95/EC Annex 7

Dimensions (mm)

3000pcs per Reel

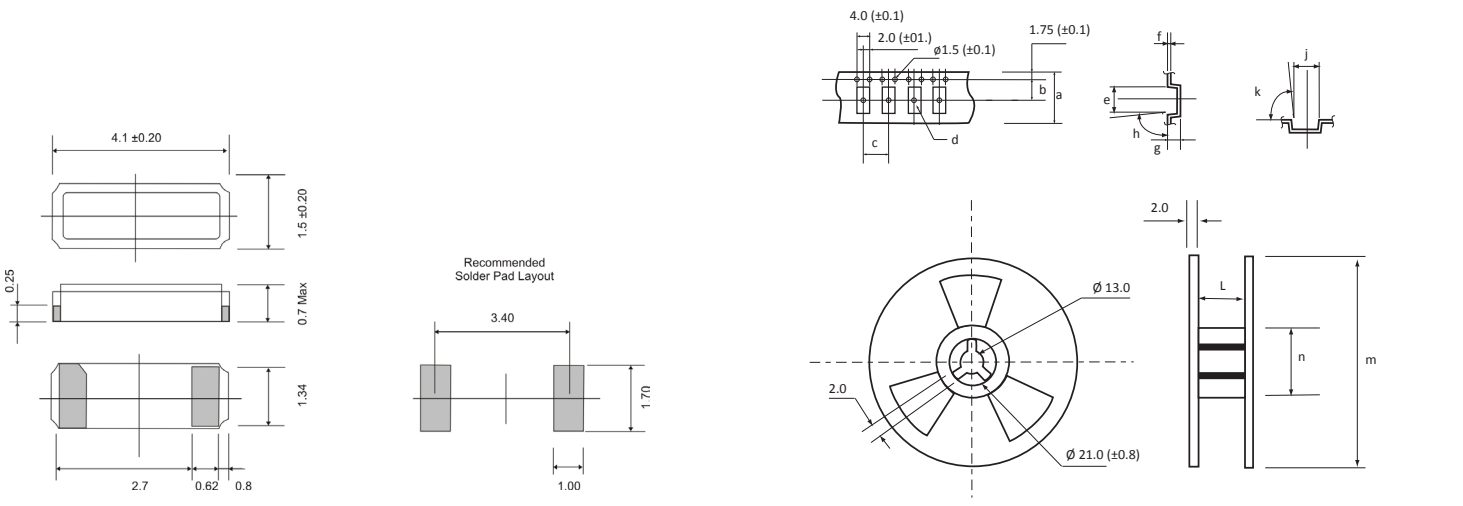

a	b	c	d	e	f	h	j	k	l	m	n
12	5.5	4.0	1.0	4.5	1.0	5°	1.9	5°	13.0	180	60